

650CAT40

650 CNC Spindle Series



The **650CAT40** delivers governed constant high speeds under load with **25,000 to 40,000 rpm**, **< 0.88 hp (0.66 kW)**. Robust and reliable, with double front ceramic bearings, the 650 Series is ideal for heavier duty applications and milling hard materials in corners. The governor-controlled turbine maintains rated high speed, optimizing tool performance and life. Effective in all materials, including tool steel, titanium and ceramic.

Ultra-low vibration and no heat in 24/7 operation. Selectable rear or side air feed on each spindle. Automatic Loading from the magazine on all machines.

650CAT40 Dimensions

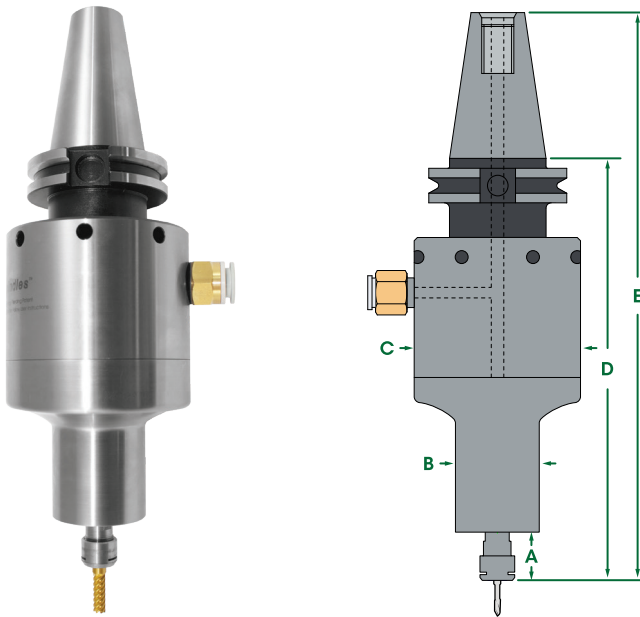

All fittings, couplings, and hoses must have a minimum of 8mm internal diameter.

A	0.87" (22mm)	C	Ø 3.23" (82mm)	E	9.88" (251mm)
B	Ø 1.62" (41mm)	D	7.7" (195mm)		

650CAT40 Specifications

Speed RPM	25,000	30,000	40,000
Power Rating hp (kW)	0.8 (0.6)	0.83 (0.62)	0.88 (0.66)
Inlet Air Pressure	90 PSI (6.2 Bar)		
Air Consumption Idle cfm (l/s)	13 (6.14)	18 (8.49)	
Air Consumption Working Flow cfm (l/s)	14 (6.61) - 35 (16.52)		
Air Hoses and Fittings Minimum Size	8mm ID		
Sound Level	Less Than 78 dBA		
Max Shank Capacity	ER11 UP - 1/4" (6mm)		
Spindle Weight	112.8 oz (3.20 kg)		

650CAT40 Series Part Numbers

ER11 UP - 1/4"		ER11 UP - 6mm	
Speed RPM	Part Number	Speed RPM	Part Number
25,000	64070	25,000	64071
30,000	64072	30,000	64073
40,000	64074	40,000	64075

Accessories

Model	Part Number
High Flow Filter / Regulator / Extractor	30008
Tube 12mm O.D. - 8mm I.D. (order by foot)	16509
Hose & Fitting - 12mm O.D. - 8mm I.D. - 12'	30045

Equipment Included

- 650CAT40 Spindle
- Combo Filter Extractor
- ER11 UP Collet System (1/4" or 6mm)
- Collet Wrenches
- Air Hose
- Fittings
- Plug (For alternate air inlet not in use.)
- Coolant Guard
- Carrying Case

Standard Equipment

ER11 UP Collet System (1/4" or 6mm collet.)

Oil-free 90 psi / 6.2 bar clean, dry air supply required.

Tel:+1.561.994.0500 • www.airturbinetools.com • ask@airturbinetools.com

Supply is subject to Air Turbine Technology Inc. (ATT) distributor policies and upon terms and conditions contained in the ATT distributor agreement. Subject to availability, change of specifications, price and terms without notice. Always use a 0.3 micron filter/extractor and check specified air flow. 6.2 Bar / 90 psi clean, dry, oil-free air only. Use eye protection and follow safety instructions. All specifications approximate. © 2024 Air Turbine Technology, Inc. All rights reserved.

Initial Installation

Install a new dedicated clean air line from the included Filter/Regulator to your Air Turbine Spindle® as shown below. **Ensure all air lines, couplings and fittings meet the minimum internal diameter of 8mm.** Any connections smaller than 8mm will restrict air flow and reduce power to your Air Turbine Spindle®. Additionally, place a plug in any air inlet that is not being used.

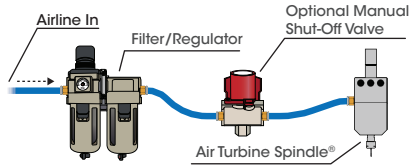

Air flow restrictions (such as air leaks) cause under power performance and damage the bearings. **Some fittings with nominal internal dimensions may have an internal diameter passage that is smaller than stated and restrict air flow and power.** It only takes one fitting with too small an internal diameter to reduce air flow and reduce power of your Air Turbine Spindle®.

Air Requirements

Do not oil or lubricate. Use dry, clean, oil free 90 psi (6.2 Bar) air supply only.

Ensure there is sufficient volume of compressed air flow at 90 PSI / 6.2 Bar with **14 (6.61) - 35 (16.52) CFM (L/S)** to maintain working air consumption. Depending on application, consider peak or stall capacity consumption. Air flow volume increases on demand to keep rotation at the high speed when your tool starts to cut. **Air Pressure and flow volume must be available on demand and remain constant with no drop over time or when cutting.**

Avoid Pressure below 90 PSI / 6.2 Bar, which causes rapid bearing wear and underpowered performance. More than 100 PSI / 6.9 bar pressure will burst the turbine power producer. Air Pressure and flow must remain constant with no drops under cutting load. Insufficient flow will cause the rotation of your tool to slow or stop suddenly, damaging the bearings. If a drop in PSI (Bar) occurs below 90 PSI (6.2 Bar), your compressor may not have enough CFM (L/S) to power the Air Turbine Spindle® or there is a flow restriction in the air line.

Maintenance

Your Air Turbine Spindle® must be run at least 10 minutes every 30 days from manufacture date to maintain optimal performance. Run at least 10 minutes before initial use.

The airline must be impeccably clean with no coupling or hose smaller than 8mm internal diameter. The included 0.3 micron filter extractor regulator combination is a necessary accessory for Air Turbine Spindles® to eliminate impurities in your air supply. Contamination will damage your turbine components and require repair. **Filter elements need to be changed and extractor drained in regular maintenance cycles.** Replacement elements are available in the Accessories section on our website.

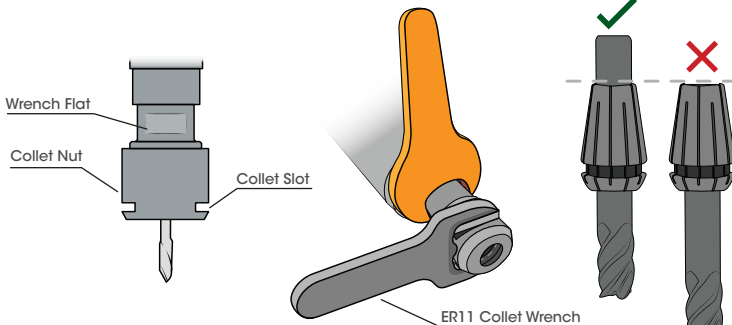

WARNING

Connection to air supply starts motor rotation. Do not connect air to your tool until installation is complete.

Operation

Purge the line of contamination and run at least 10 minutes before initial use to ensure the bearing lubrication does not solidify.

Always monitor Air Pressure Gage during operation of your Air Turbine Spindle®. The key to successful high-speed machining and optimized tool performance is to program light passes at very high feed rates. Start with a light pass observing surface finish quality and gradually step down or increase your rate of advance for optimal cutting conditions. Do not try to cut too aggressively. You will overload your turbine causing your cutting tool to stall or drag in the material. Dragging your tool or a sudden stop will cause stress to the bearings and causing premature failure.

Programming your Air Turbine Spindle®

Apart from a few instances, Air Turbine Spindles® will run your normal CAM programs. All you need to do is remove the Spindle RPM command (S3000) and the Rotation direction command (M3 or M4). At high speed a small concentric speed rated cutting tool should be used with a fast advance using shallow depths of cut. This layering programming technique produces clean cutting action and optimizes tool performance and life.

Spindle Commands

Gradually increase depth of cut to establish optimal cutting conditions. Use M05 on Fanuc type controls to ensure main spindle is turned off. **Always ensure main spindle is programmed not to rotate (S0/M05).**

Canned Cycles

Beware that on CNC controls the G81, G82, G83 (peck drilling) commands will turn on the machine spindle, even with M05 (spindle stop). In most drilling applications you will not need to peck thanks to the high-speed of your Air Turbine Spindle®. There are several alternative solutions: Some CAM programs will allow you to program to drill without a canned cycle or you could program the path long hand or you can use macros.

Dry Run, Graphic Run

Always run the CNC machine program in Graphics and/or in a slow dry run to verify that the CNC spindle does not turn on and that you have no obstruction.

Disable CNC Main Spindle RPM

Program your CNC machine control to allow for normal operation without spindle rotation.

Installation or Removal of Collet and Cutting Tool

1. Take the wrench included with your Air Turbine Spindle® and insert it to the wrench flat of your Air Turbine Tool's shaft.
2. Take the ER11 collet wrench included with your Air Turbine Spindle® and apply it on the collet slot as shown in the left diagram. Turn the wrench counterclockwise to release the current cutting tool.
3. After the cutting tool is free, continue to turn the collet nut counterclockwise with the ER11 collet wrench to fully remove the collet nut and release the existing collet. Remove the wrench from the shaft.
4. Remove the existing collet from the shaft and replace it with the new collet. Re-apply the collet nut by turning it clockwise on the shaft. **The 650 series of Air Turbine Spindles® requires 7 ft-lbs of torque to tighten.**
5. Insert the new cutting tool by sliding it into the shaft of your tool. Ensure that the new cutting tool goes completely through the collet as shown to the left. **The stick-out extension length of the cutting tool from your collet should optimally be no more than 3 times the diameter of your cutting tool.**
6. Re-insert the wrench onto the wrench flat of your Air Turbine Tool's shaft and turn the collet nut clockwise until it's firmly held. **Do not over tighten the collet nut.** The ER11 collet nut used for the 650 series of Air Turbine Spindles® requires 7 ft-lbs of torque to tighten.
7. Insert the collet wrench into the collet nut and turn it clockwise to ensure the new collet and cutting tool is firmly held.



Scan to consult full user instructions.